

Measurements in millimetres mm

Information updated January 2020







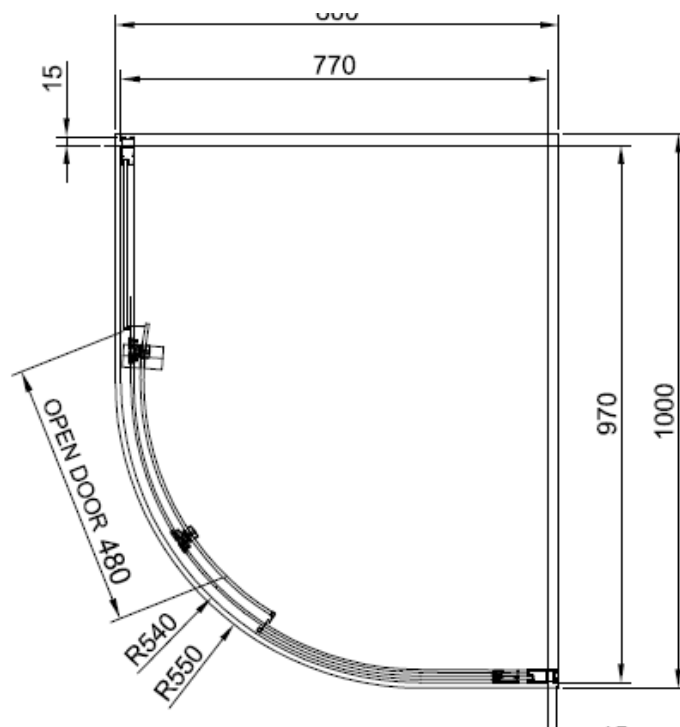
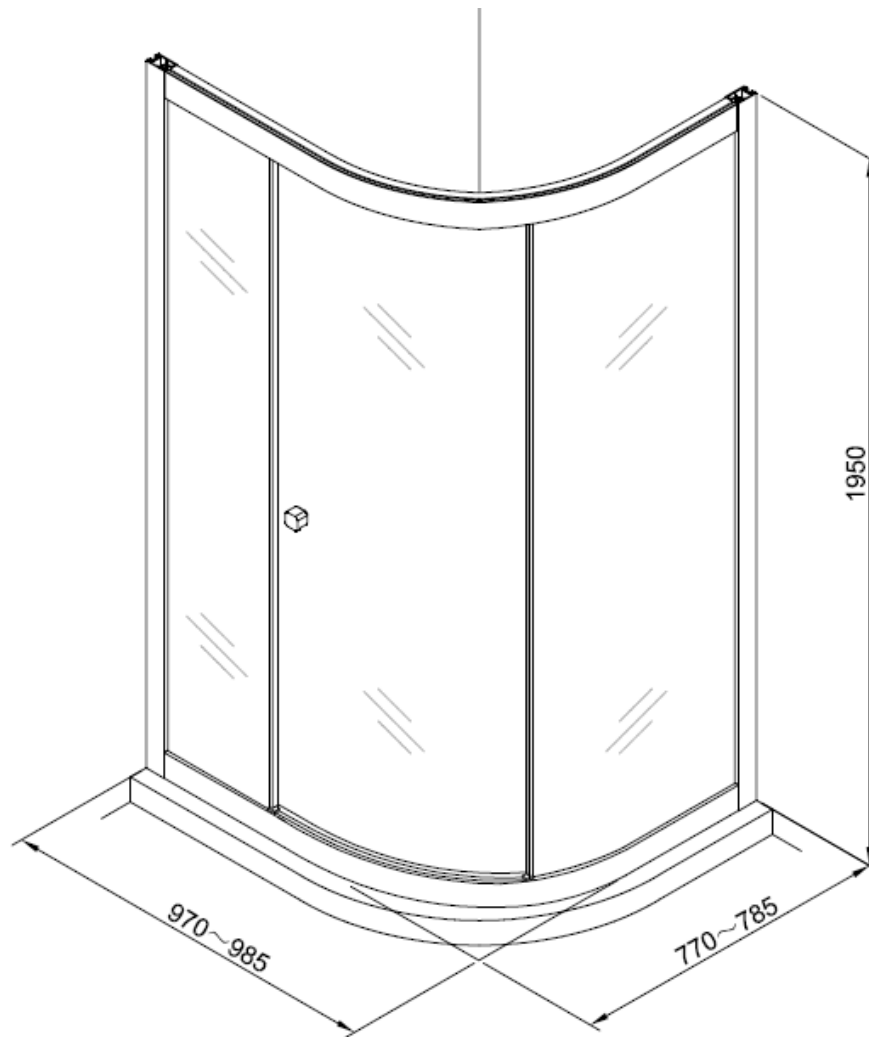

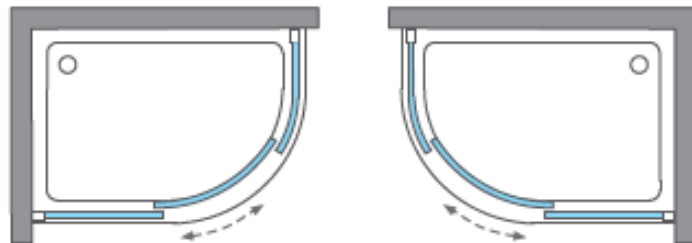
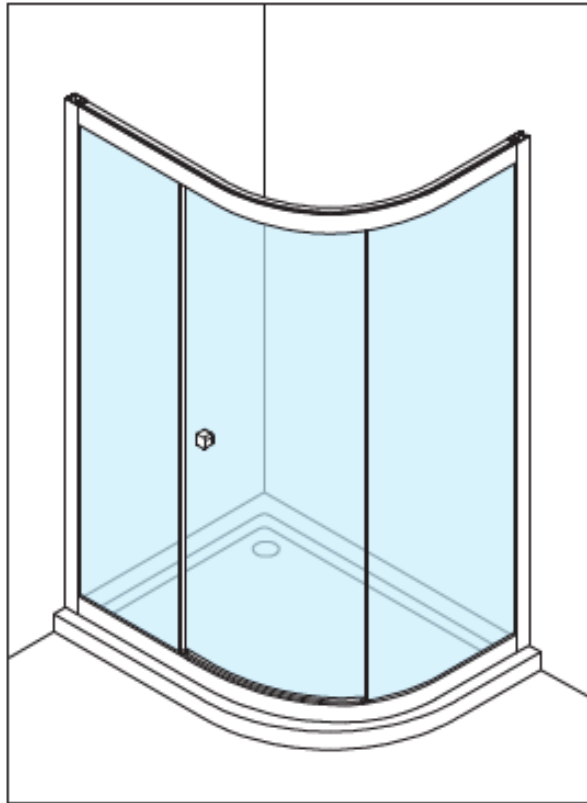

Tel 0345 873 8840

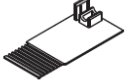
crosswater[™]

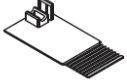
CLEAR 6 SINGLE DOOR QUADRANT CAQSSC10X8





<p>A</p>  <p>M4 *40mm Screw x 6</p>	<p>E</p>  <p>Waterproof strip x 1</p>	<p>I</p>  <p>Top Cap x 1</p>
<p>B</p>  <p>M4 *30mm Screw x 8</p>	<p>F</p>  <p>Waterproof strip x 1</p>	<p>J</p>  <p>Top Cap x 1</p>
<p>C</p>  <p>Wall Plug x 6</p>	<p>G</p>  <p>Waterproof strip x 1</p>	<p>K</p>  <p>Spanner x 1</p>
<p>D</p>  <p>Cover x 4</p>	<p>H</p>  <p>Handle x 1</p>	

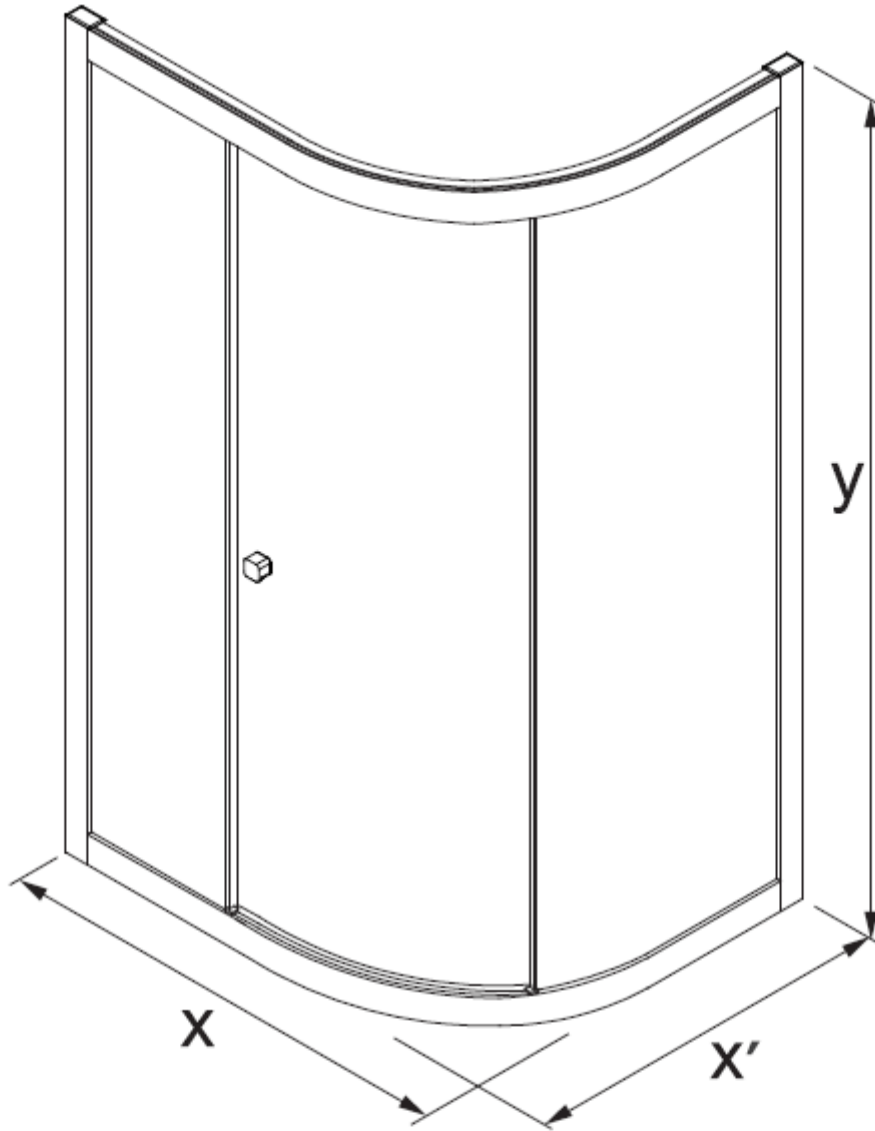

Model	X (mm)	X'(mm)	y (mm)
CAQSSC0800	770~785	770~785	1950
CAQSBC0800	770~785	770~785	1950
CAQSSC0900	870~885	870~885	1950
CAQSBC0900	870~885	870~885	1950
CAQSSC10X8	970~985	770~785	1950
CAQSBC10X8	970~985	770~785	1950
CAQSSC12X8	1170~1185	770~785	1950
CAQSSC12X9	1170~1185	870~885	1950